

- \* Hi-power supply : 100mA/12VDC
- \* Hi-speed response time : 0.2ms
- \* Hi-reliability with hi-anti-noise circuit.
- \* Easy to test with input pilotlamp.
- \* Easy to longer distance monitor with large size LED display.
- \* Long time memory with Ni-Cd battery.

**Illustration**

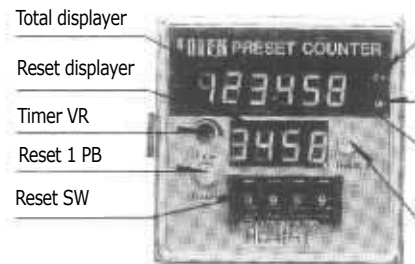

**Outline & Fixed Hole**

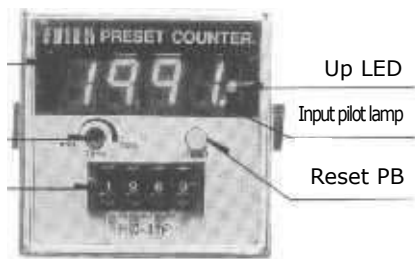
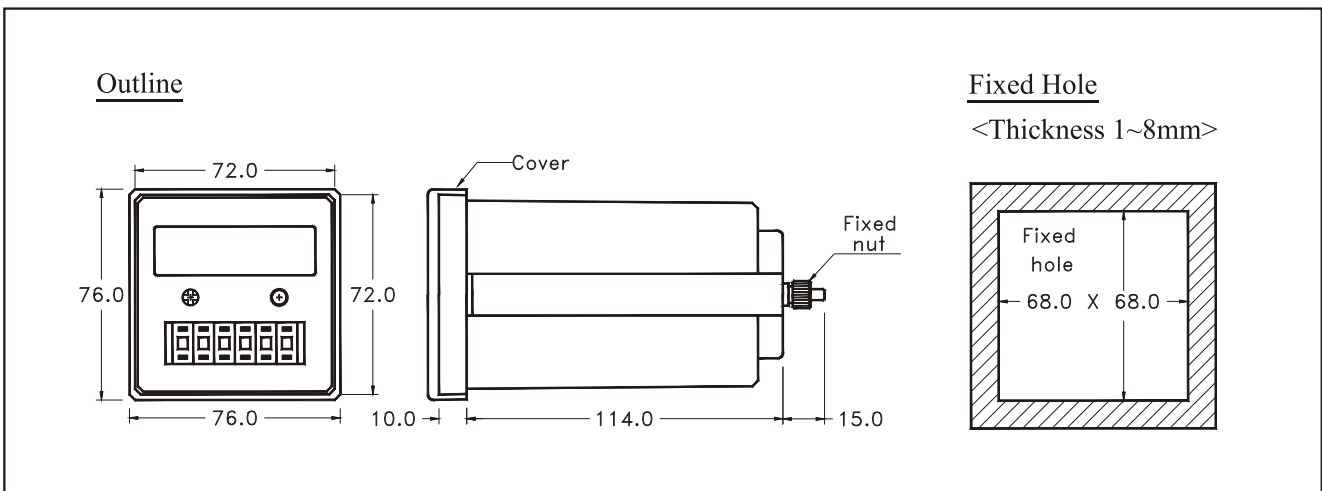

## A/B Slide Switch < Response Time Selected >

Counting	L→H	$0V \leq L < 2V$ , $6V \leq H < 30$ / Enabling Current $< I_e > < 3mA/12V$
Mode " A "	2.5K CPS	Cycle Duty Ratio 1:1 , Suited for Solid State Input Such As CMOS , TTL or Transister etc.
Mode " B "	60 CPS	Response Time < 15ms , Suited for Contact input Such As Limit Sw , Relay or Reed SW etc.

## N/R/C Slide Switch < Output Control Selected >

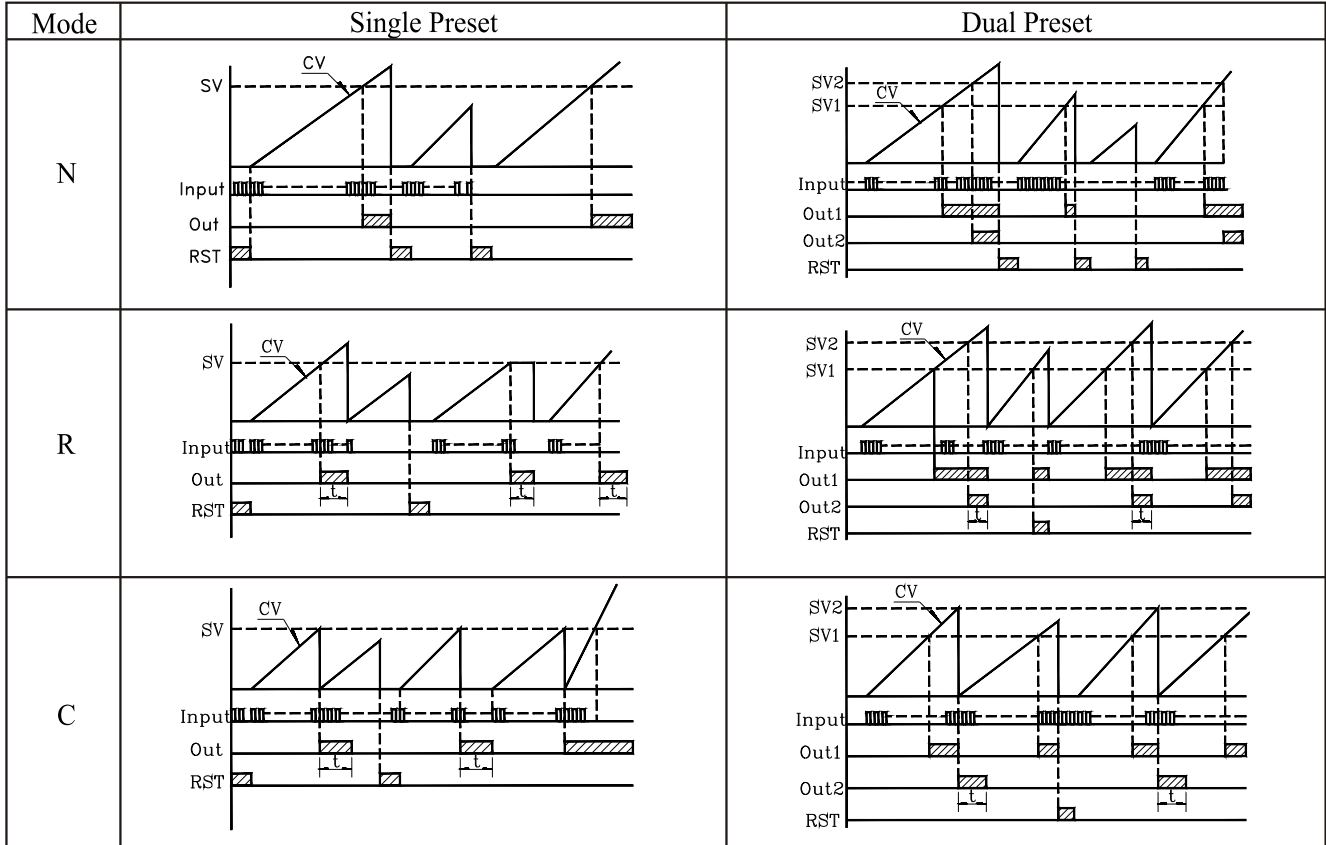

## Connection Diagram

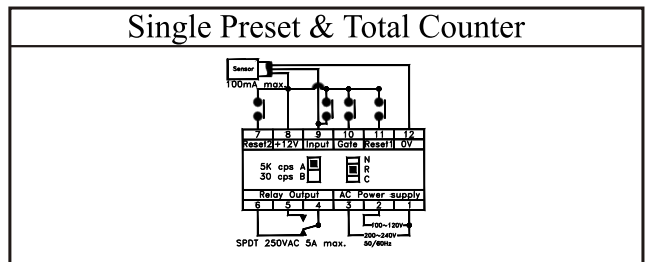
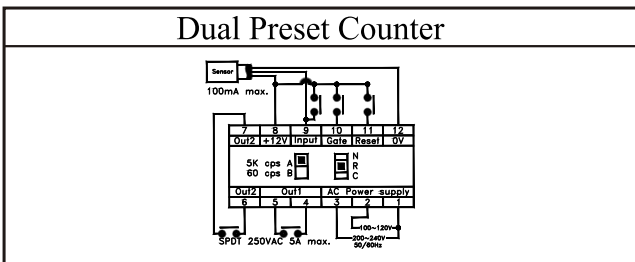
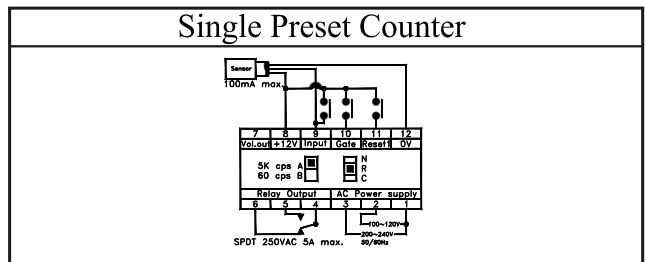
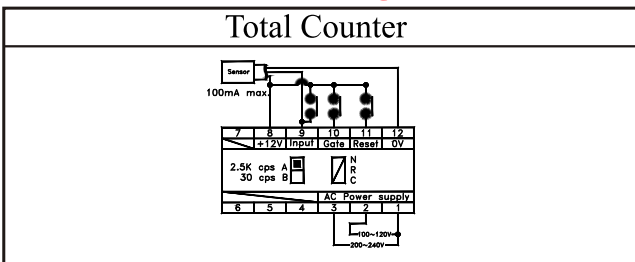

## Total Counter



Model	HC-4T	HC-5T	HC-6T
Nr. of displayer	4 digits	5 digits	6 digits
Display range	0000~9999	00000~99999	000000~999999
Display method	0.56" 7-segment red LED	0.36" 7-segment red LED	
Response frequency	Contact input < 60 cps ; Non-contact input < 2.5K cps		
Operating voltage	110/220VAC $\pm 20\%$ , 50/60Hz		
Current Consumption	5VA max.		
Weight	Approx.650g.		

## Single Preset Counter



Model	HC-21P	HC-31P	HC-41P	HC-51P	HC-61P
Nr. of displayer	2 digits	3 digits	4 digits	5 digits	6 digits
Setting range	1~99	1~999	1~9999	1~99999	1~999999
Display method	0.56" 7-segment red LED	0.36" 7-segment red LED			
Response frequency	Contact input < 60 cps ; Non-contact input < 2.5K cps				
Output method	Relay output 1a / 1b , 5A/250VAC max. Voltage output PNP , 150mA max.				
Output control	N.R.C. control				
Operating voltage	110/220VAC +20% , 50/60Hz				
Current Consumption	5VA max.				
Weight	Approx.650g.				

## Interface Circuit

Voltage Output < 7th Pin >

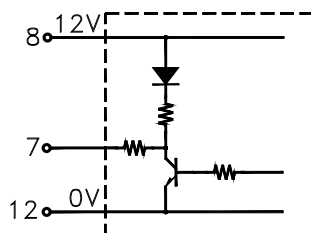

Input < 9th Pin >

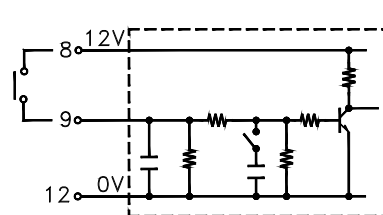

## ■ Dual Preset Counter



Model	HC-42P	HC-52P	Standard type : 1st preset output is controlled by 2nd preset output with N.R.C. Optional type : 1st preset output is controlled with one shot < 0.1s > , 2nd preset output is controlled with N.R.C.
Nr.of displayer	4 digits	5 digits	
Setting range	1st 1~9999 2nd 1~9999	1st 1~99999 2nd 1~99999	
Display method	0.36" 7-segment red LED		
Response frequency	High Speed<2.5K cps ; Low Speed<60 cps		
Output method	Two relays , 1a 5A/250VAC		
Output control	N.R.C control		
Operating voltage	110/220VAC ± 20% , 50/60Hz		
Current consumption	5VA max.		
Weight	Approx. 700g.		

## ■ Single Preset & Total Counter



Model	HC-4P6T	Standard type : The total Counter is synchronously Counting with the preset counter. Optional type : The total Counter Counts when preset counter output.<HC-4P6TA>
Nr.of displayer	Preset 4 digits , total 6 digits	
Display range	0000~9999 & 000000~999999	
Setting range	1~9999	
Display method	0.36" 7-segment red LED	
Response frequency	High Speed<1K cps ; Low Speed<60 cps	
Output method	Relays	
Output control	N.R.C control	
Operating voltage	110/220VAC ± 20% , 50/60Hz	
Current consumption	5VA max.	
Weight	Approx. 700g.	

## ■ Interface Circuit

